

31

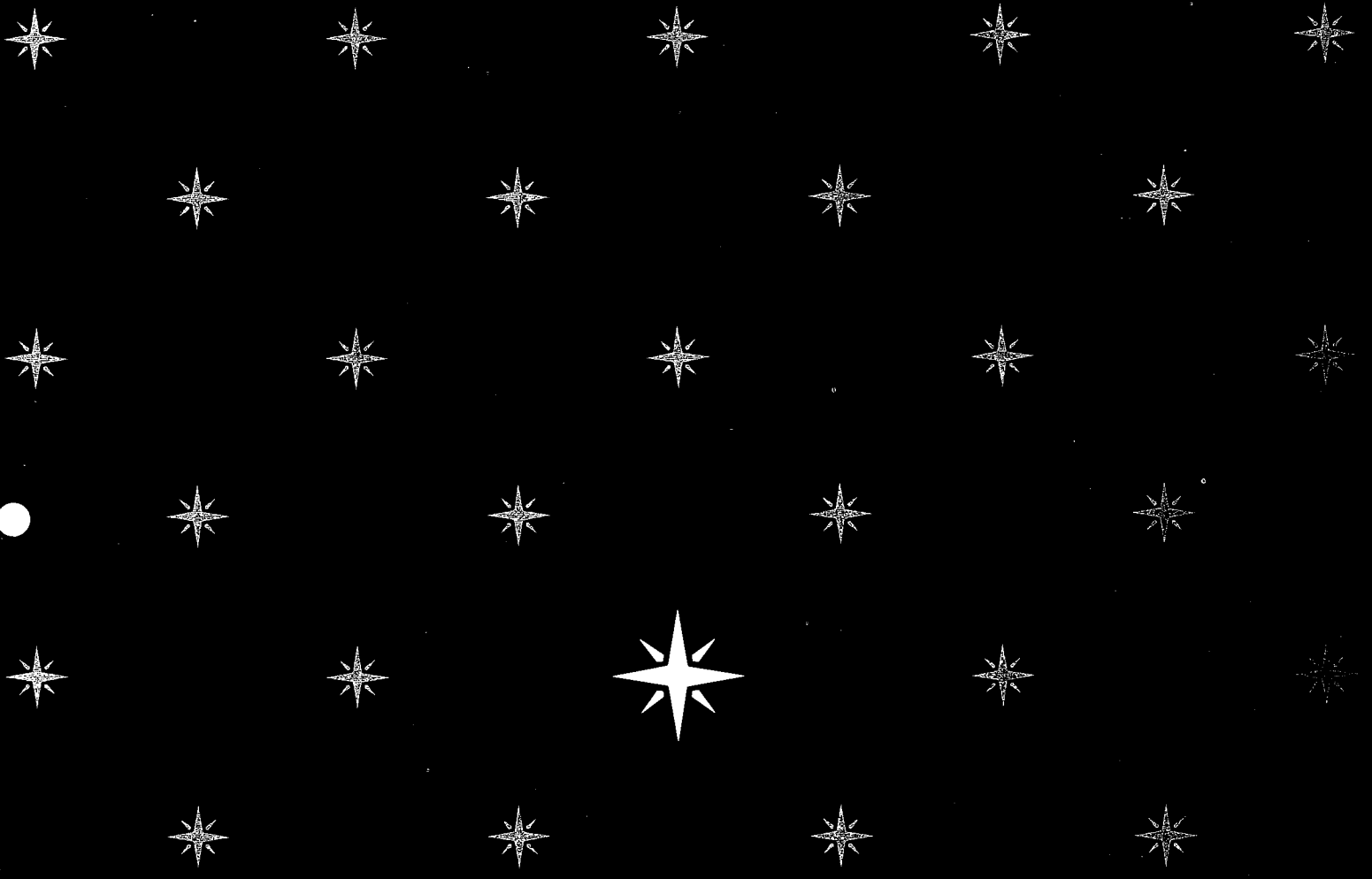

SERVICE MANUAL 1070



marantz

model 1070

Console Stereo Amplifier

TABLE OF CONTENTS

SECTION	PAGE
Introduction	1
Pre-Amplifier	1
Main Amplifier	1
Trouble Analysis	2
Power Amplifier Adjustment	2
Power Supply Unit	2
Test Equipment Required of Servicing	2
Performance Verification	4
Parts List	15
Specifications	21
Service Information for European Model	22

LIST OF ILLUSTRATIONS

FIGURE	PAGE
1. AC Power Control Box Simplified Schematic	1
2. Amplifier Output Load Box Simplified Schematic	2
3. Front Panel Adjustment Component Locations	6
4. Main Chassis Component Locations (Top View)	6
5. Rear Panel Adjustment and Component Locations	7
6. Main Chassis Component Locations (Bottom View)	7
7. Phono Amplifier Assembly P400 Component Locations	8
8. Main Assembly P700 Component Locations	8
9. Power Supply Circuit Assembly P800 Component Locations	9
10. Tone and Pre-Amplifier Assembly PE01 Component Locations	9
11. Speaker Loudness Assembly PT01 Component Locations	10
12. Tone Control Volume Unit Assembly PF01 Component Locations	10
13. High and Low Filter Unit Assembly PH01 Component Locations	10
14. Exploded Mechanical Diagram	11
15. Schematic Diagram	13
16. Rear Panel Adjustments and Facilities Locations for European Model	23
17. Main Chassis Component Locations (Top View) for European Model	23
18. Voltage Conversion Chart	24
19. Schematic Diagram for European Model	25

1. INTRODUCTION

This service manual was prepared for use by Authorized Warranty Stations and contains service information for the Marantz Model 1070 Stereo Console Amplifier.

Servicing information and voltage data included in this manual are intended for use by knowledgeable and experienced personnel only. All instructions should be read carefully. No attempt should be made to proceed without a good understanding of circuitry operation.

The parts list furnishes complete ordering information. Most replacement parts should be ordered from the Marantz Company. However, a simple description is included for parts which can be obtained locally.

2. PRE-AMPLIFIER

Signals from the input jacks (TUNER, TAPE-1, TAPE-2 & AUX) are applied to the selector switch.

Signals from the PHONO MIC jacks are applied to the other section of the selector switch, then to the phono-amplifier and equalized for proper frequency response. The gain of the phono-amplifier (H401, H403 and H405) is 40dB.

The outputs of the phono-amplifier are fed to the selector switch. The selector switch selects one of signals from MIC, PHONO, TUNER, AUX, TAPE 1, TAPE 2 jacks and feeds it to the TAPE MONITOR switch and TAPE OUT jacks. The selected signal is then applied to the MODE switch, to the balance and volume controls, and finally to the preamplifier consisting of HE01, HE03, HE05 and HE07.

The frequency response is controlled by the Bass, Middle and Treble controls and the resultant output is passed to the PRE OUT jacks through the High-cut and Low-cut filter networks. These networks are switched in and out of the circuit by the filter switches.

3. MAIN AMPLIFIER

The main amplifier consists of differential pre-amplifiers H701 and H703, class "A" driver H707 and direct-coupled drivers H721 and H722.

H709 and H711 act as current limiters.

H726, H727 and H728 form a protector circuit. It protects the speaker from damage due to POWER SWITCH transients or excessively high DC voltage.

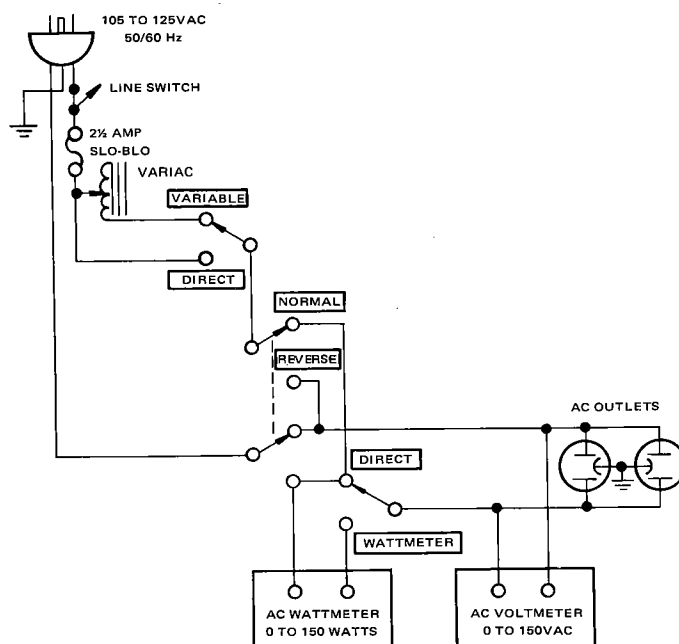

Figure 1. AC Power Control Box Simplified Schematic

4. TROUBLESHOOTING ANALYSIS

- 1. Excessive line consumption
 - a. Check for shorted H801, H802, H803.
 - b. Check for shorted transistor H001, through H004.
 - c. Check for open H005, H006, R733, R734.
- 2. No line consumption or zero bias voltage
 - a. Check line cord, fuse, check for shorted H005, H006 R733, R734.
 - b. Check for open rectifiers H801, H802, H803 or open L001.
- 3. High hum and noise level
 - a. Check filter capacitors C001, C002, C803, C804.
- 4. Parasitic oscillation
 - a. Check C703, C704, C707, C708, C715, C716

5. POWER AMPLIFIER ADJUSTMENT

1. Adjustment of Idling current

Connect VTVM between J714 and J716. Adjust R733 until the meter reads 10mV. Similarly, connect VTVM between J715 and J717 and adjust R734 until the meter reads 10mV.

2. DC-OFFSET adjustment

Connect VTVM to J723 and J722 (or ground) and adjust R711 until the meter indication reaches 0mV ($\pm 5mV$). Similarly, connect VTVM to R724 and J722 (or ground) and adjust R712 until the meter indication reaches 0mV ($\pm 5mV$).

6. POWER SUPPLY ADJUSTMENT

Connect a voltmeter between J810 and J811. Adjust R807 until meter indicates 40 VDC.

7. TEST EQUIPMENT REQUIRED FOR SERVICING

Table 1 lists the test equipment required for servicing the Model 1070 Stereo Console Amplifier. The wattmeter, ac voltmeter, and variable autotransformer may be assembled as a test fixture as shown schematically in Figure 1. The load resistors and ac ammeter may be assembled into a second test fixture as shown in Figure 2.

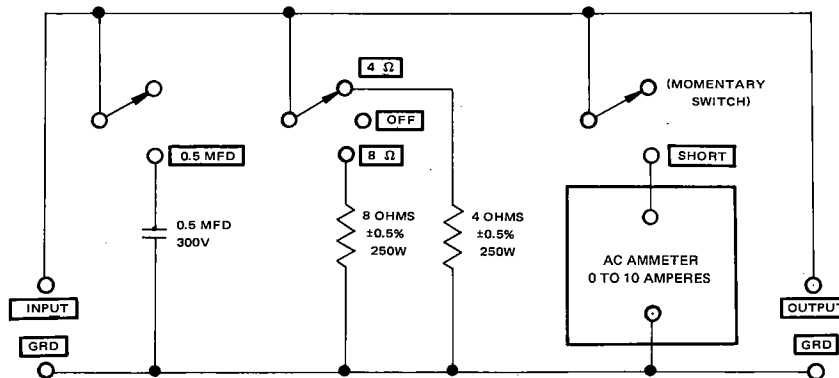

Figure 2. Amplifier Output Load Box Simplified Schematic

Item	Manufacturer and Model No. (or equivalent)	Function
Distortion Analyzer	Hewlett Packard, Model 331A or 333A	Measures distortion and voltage of amplifier output.
Audio Oscillator	Weston Model CVO-100P (NOTE: Less than 0.02 percent residual distortion is required.)	Sinewave and squarewave signal source.
Oscilloscope	Tektronix, Model 503; Data, Model 555	Waveform analysis and troubleshooting.
VTVM	RCA Senior Volt-Ohmyst, Model WV-98C	Voltage and resistance measurements.
AC Wattmeter	Simpson, Model 390	Monitors primary power consumption of amplifier.
AC Ammeter (0 to 10 amps)	Commercial Grade	Monitors amplifier output under short circuit condition.
Line Voltmeter (0 to 150 vac)	Commercial Grade	Monitors potential of primary power to amplifier.
Variable Autotransformer (0 to 140 vac, 10 amps)	Powerstat, Model 116B	Adjusts level of primary power to amplifier.
Shorting Plug	Use phono plug with 600 ohms across center pin and shell.	Shorts amplifier input to eliminate noise pickup.
Power Supply Bleeder Resistor (10 ohms at 1W)	Commercial Grade	Discharges power supply filter capacitors prior to disassembly or resistance measurements.
Output Load Resistor (8 \pm 0.5%, 250W)	Commercial Grade	Provides 8-ohm load for amplifier output termination.
Output Load Resistor (4 \pm 5%, 250W)	Commercial Grade	Provides 4-ohm load for amplifier output termination.
Output Load Capacitor (0.5 mfd)	Mylar	Provides capacitive load for instability checks.
AC Power Control Box	Optional Item. Fabricate in accordance with Figure 1.	Monitors and controls primary power for amplifier.
Amplifier Output Load Box	Optional Item. Fabricate in accordance with Figure 2.	Provides various amplifier loads and can monitor shorted output.

8. PERFORMANCE VERIFICATION

Test Procedure

A. Test Equipment

Refer to Table 1 for required test equipment.

B. Preliminary Procedures

1. Make the test setup shown in Figure 1 with the instrument controls set in the following positions:

Line Switch	OFF
Variable-line switch variable	
Wattmeter Switch	ON
Variable Autotransformer	0V (fully CCW)
Load	8 ohms (0.5 mfd – OFF)
Audio Generator	
Frequency	1 KHz
Output	5V range
Gain	Minimum
AC VTVM	30V range

2. Make sure that connections between the resistive load and the system terminals of the Model 1070 have negligible resistance when compared with the resistance of the load itself. Appreciable resistance in wiring adds to the total load, resulting in inaccurate measurements of output power.
3. Connect amplifier output to load and connect AC cord to line power. Connect shorting plugs to the Phono input jacks of the model 1070.

C. Total Hum and Noise Test

1. With shorting plugs connected to the Phono input jacks and an 8 ohm resistive load connected across the speaker system output terminals, connect a distortion analyzer across the load.

NOTE: If the distortion analyzer does not contain a built-in voltmeter, an AC VTVM may be substituted.

2. Set the distortion analyzer controls for voltage measurements and apply power to the amplifier. Set the volume control fully CCW. Set the SELECTOR switch to PHONO.
3. If the distortion analyzer indicates more than 2.0 mV refer to the trouble analysis section of this manual.
4. Set the volume control fully CW. If the distortion analyzer indicates more than 20 mV refer to the trouble analysis section of this manual.

D. Maximum Power Output

1. Connect the audio oscillator to the AUX input. Set audio oscillator frequency to 1 KHz. Set SELECTOR switch to AUX.
2. With the distortion analyzer connected across the output load (8-ohm), set the analyzer on the 30 VAC scale.
3. Turn the analyzer on and increase the audio oscillator output to 180 mV. The AC VTVM should read 16.8 VAC or more.

E. Harmonic Distortion Test

1. Set the frequency of the audio oscillator and the distortion analyzer to 20 KHz.
2. Set the controls of the analyzer for voltage measurement on the 30 volt scale.
3. Adjust the audio oscillator output level until the analyzer meter indicates 16.8 VAC.
4. Switch the distortion analyzer to Set Level and adjust SENSITIVITY for full scale reading on 0–1% scale.
5. Measure the total harmonic distortion with the analyzer and verify it is less than 0.3%.

NOTE: Any parasitic oscillation in the amplifier will be displayed on the oscilloscope when capacitance is switched into the load.

6. Switch the distortion analyzer back to SET LEVEL. (Do not readjust sensitivity of analyzer.)
7. Change the frequency of the audio oscillator and distortion analyzer to 1 KHz. Adjust audio oscillator output for a full scale reading on the 0—1% scale.
8. Measure the distortion, verifying it is no greater than 0.3%.
9. Repeat steps 7 and 8, changing frequency to 20 Hz. Distortion should be no more than 0.3%.
10. Check for parasitic oscillation; there should be none.

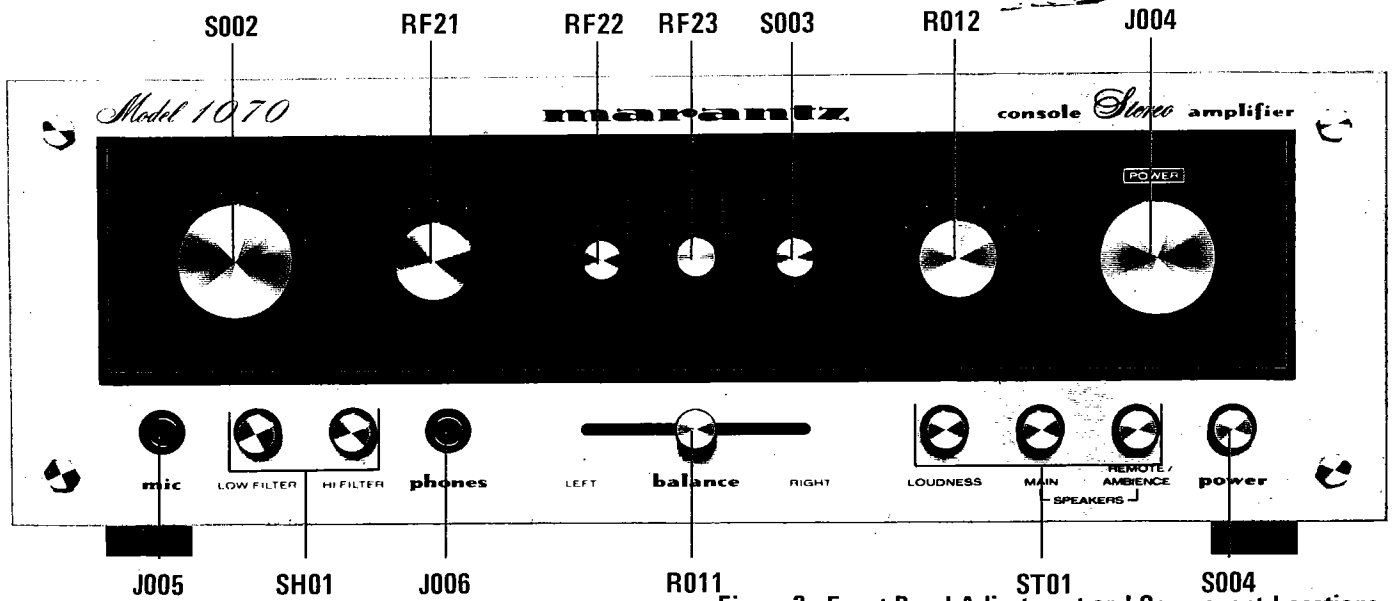

Figure 3. Front Panel Adjustment and Component Locations

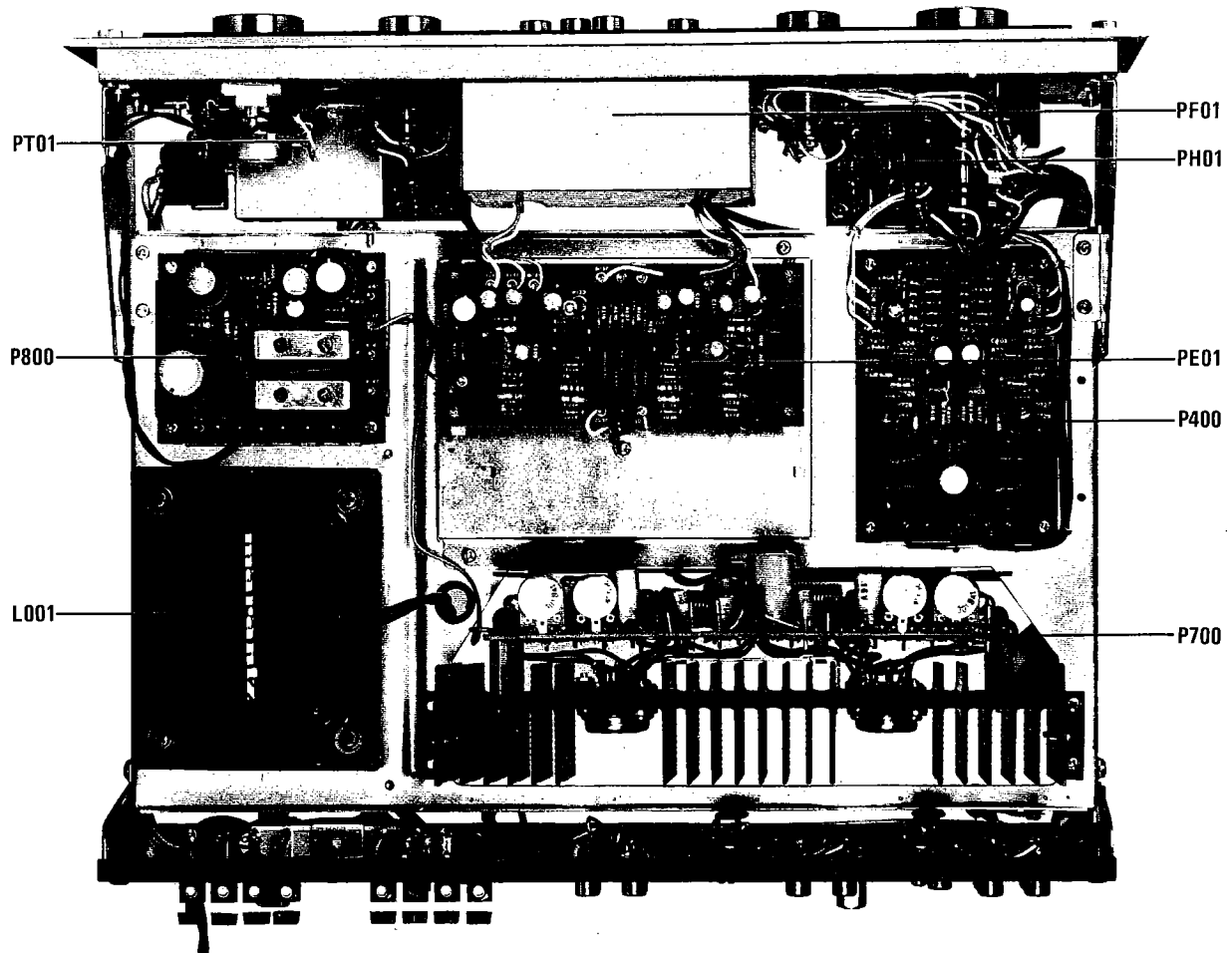

Figure 4. Main Chassis Component Locations (Top View)

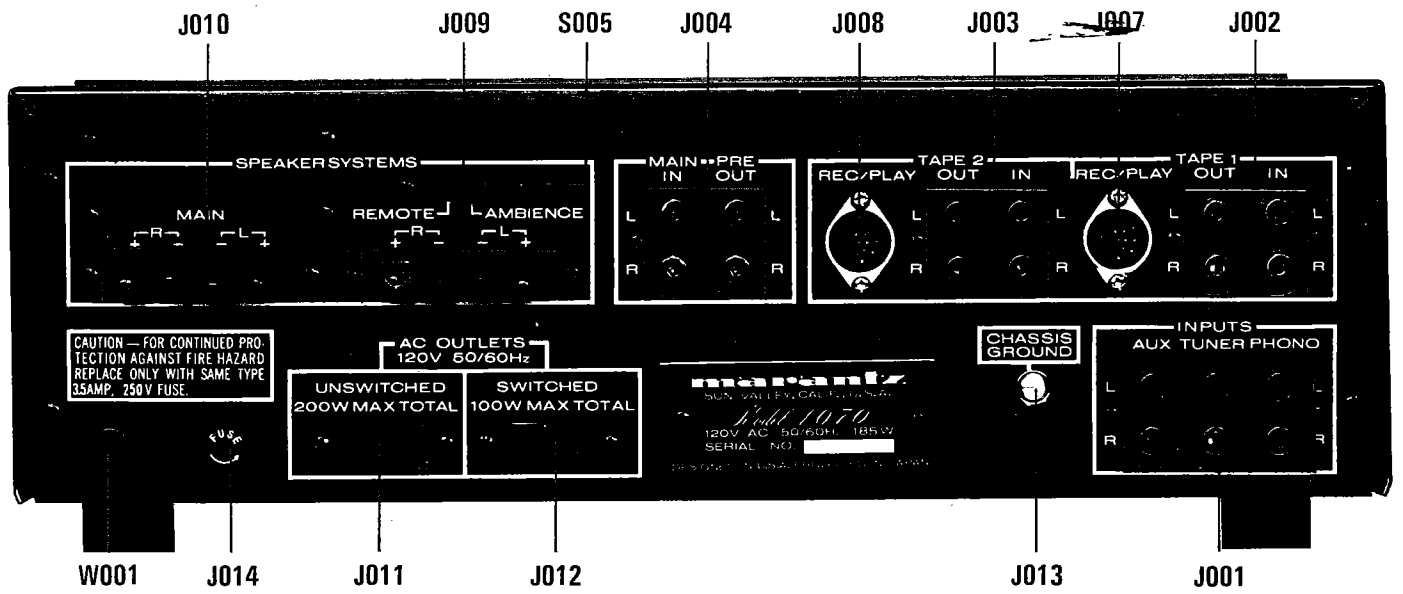

Figure 5. Rear Panel Adjustment and Component Locations

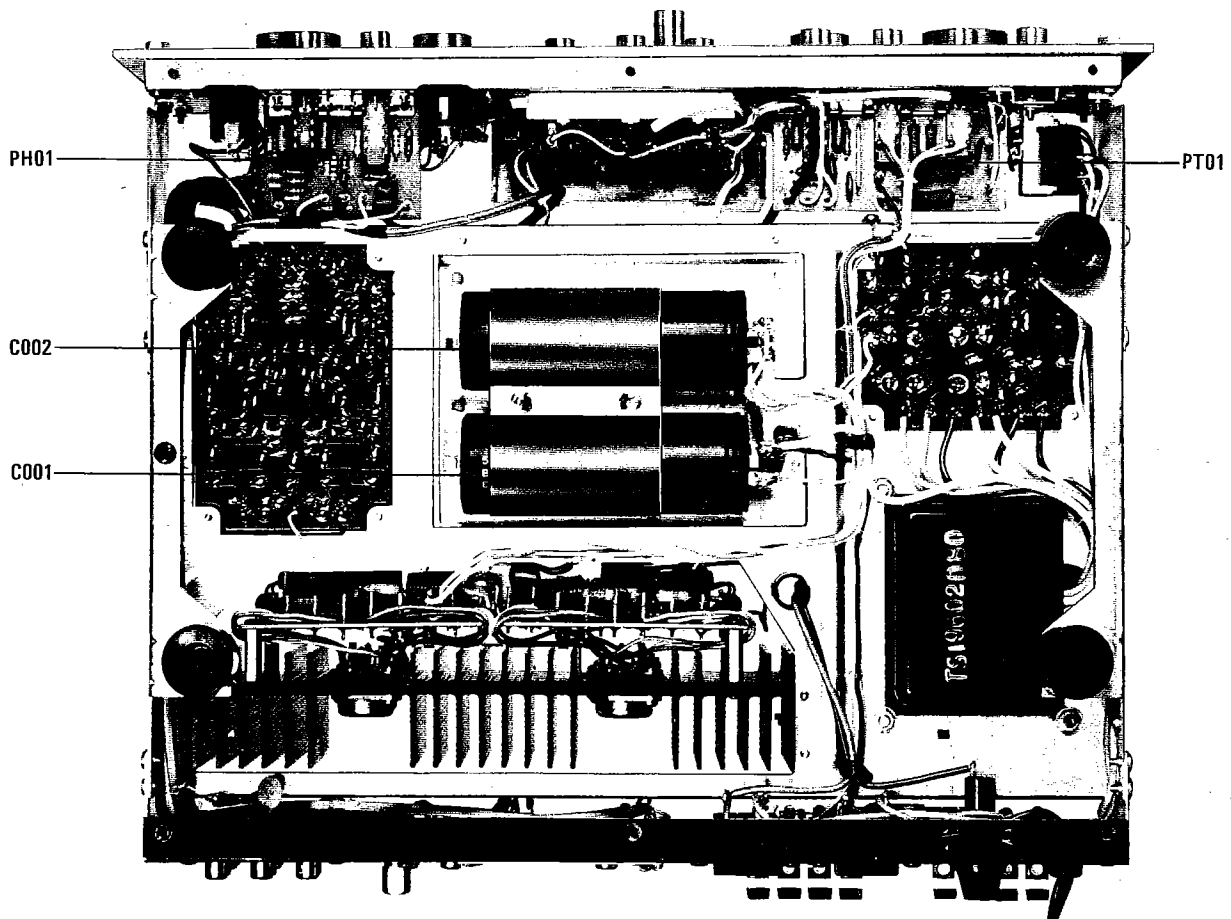

Figure 6. Main Chassis Component Locations (Bottom View)

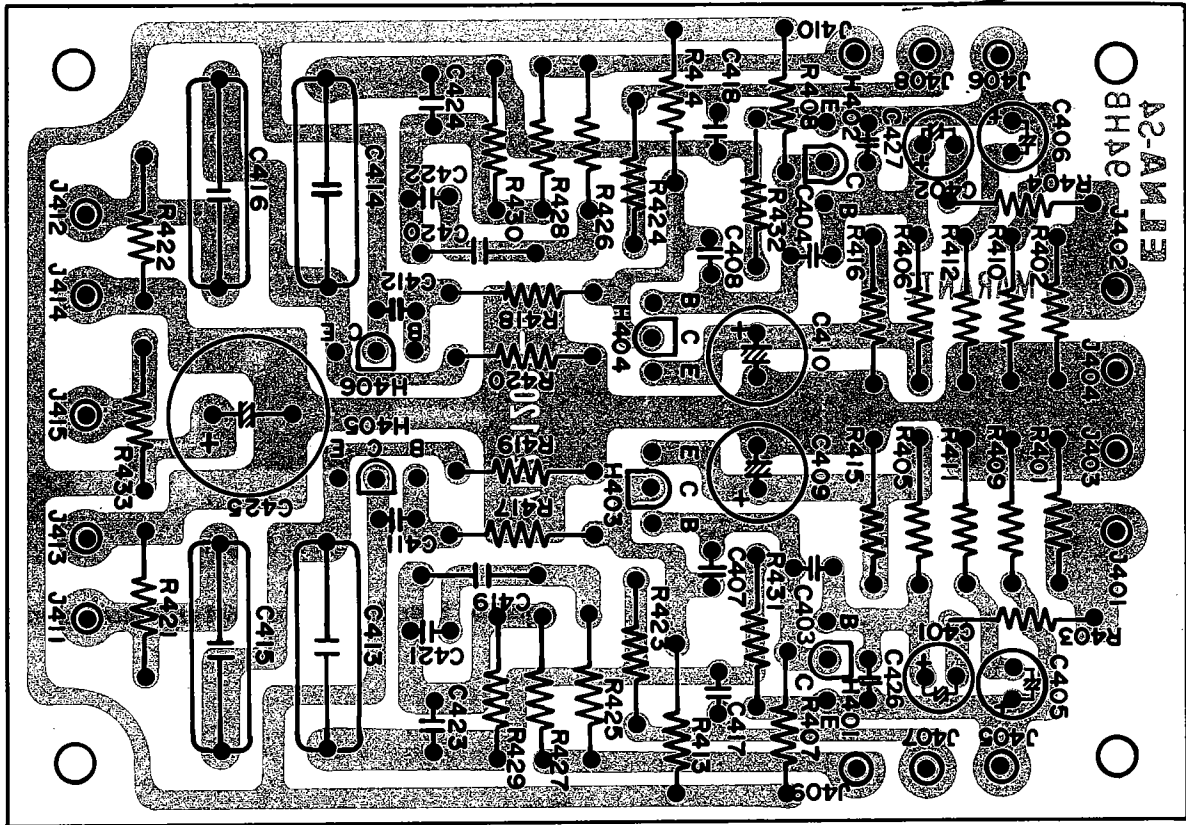

Figure 7. Phono Amplifier Assembly P400 Component Locations

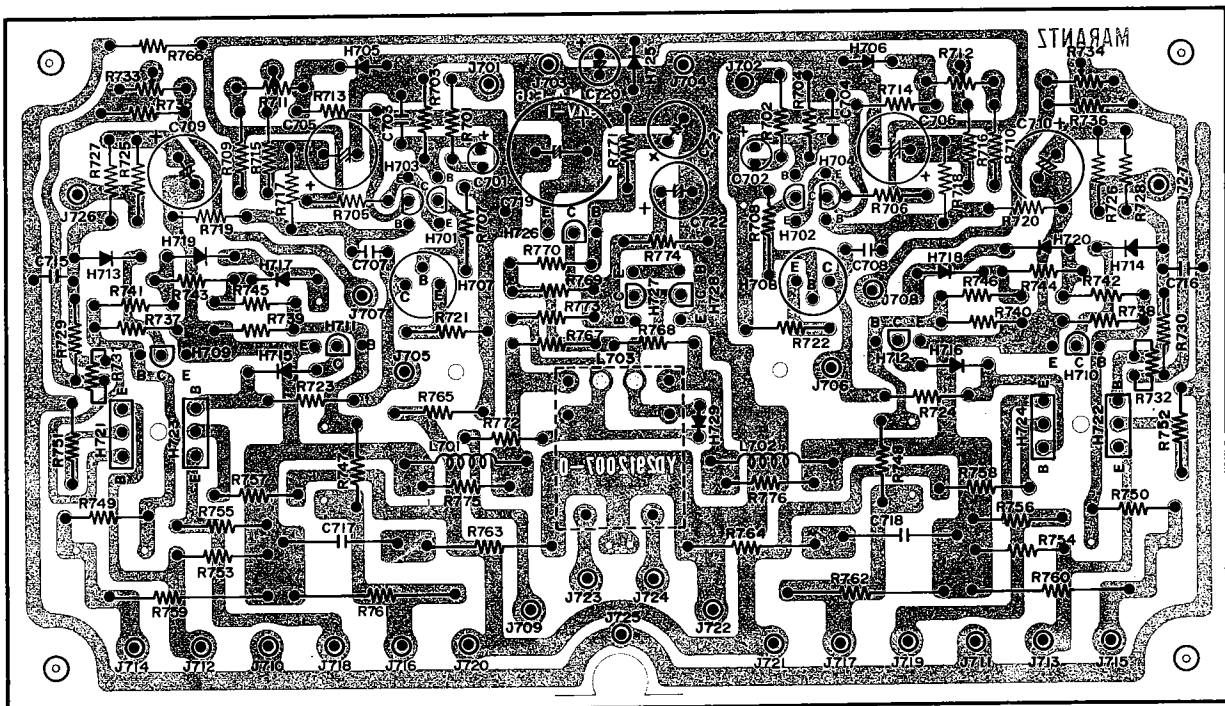

Figure 8. Main Assembly P700 Component Locations

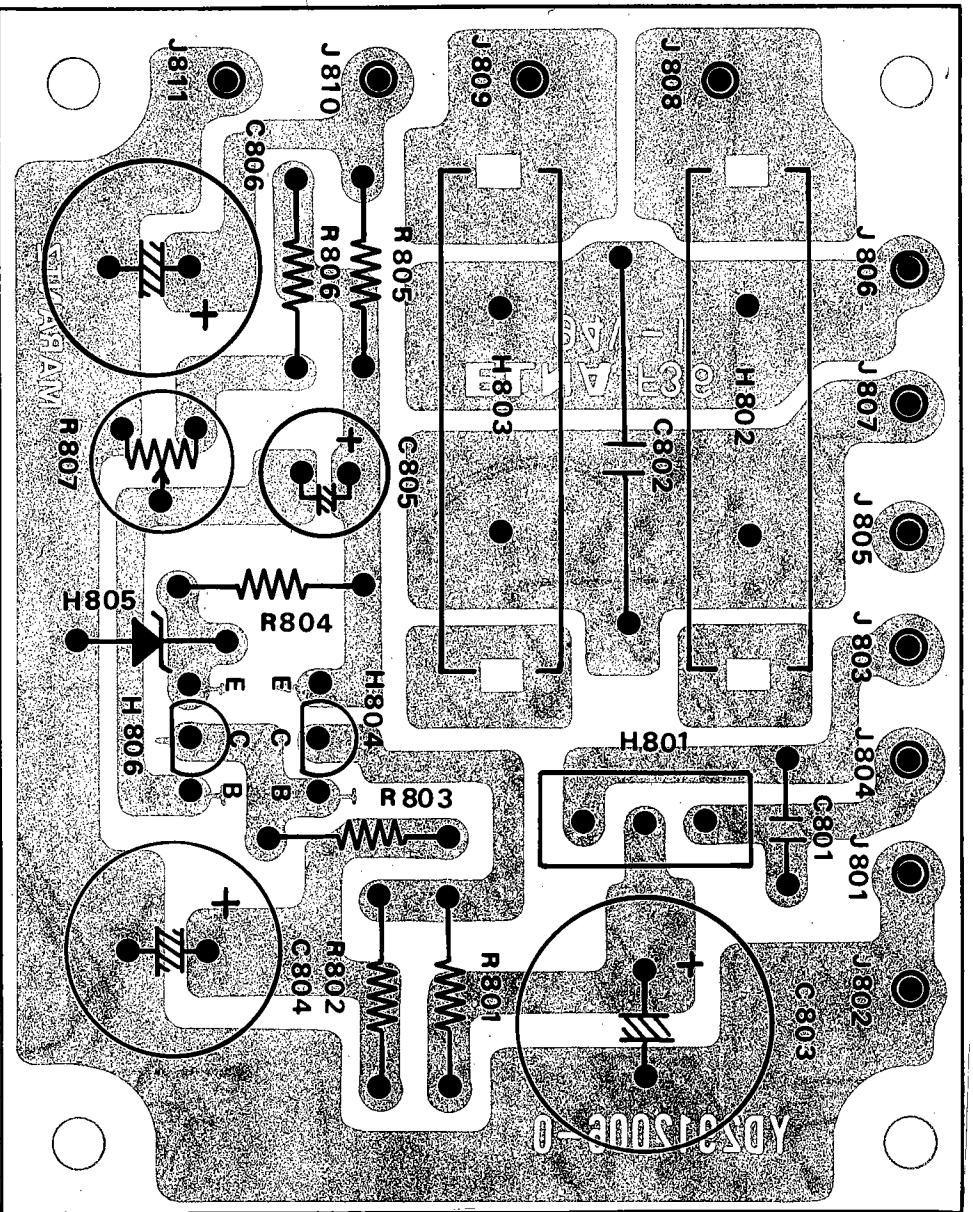

Figure 9. Power Supply Circuit Assembly P800 Component Locations

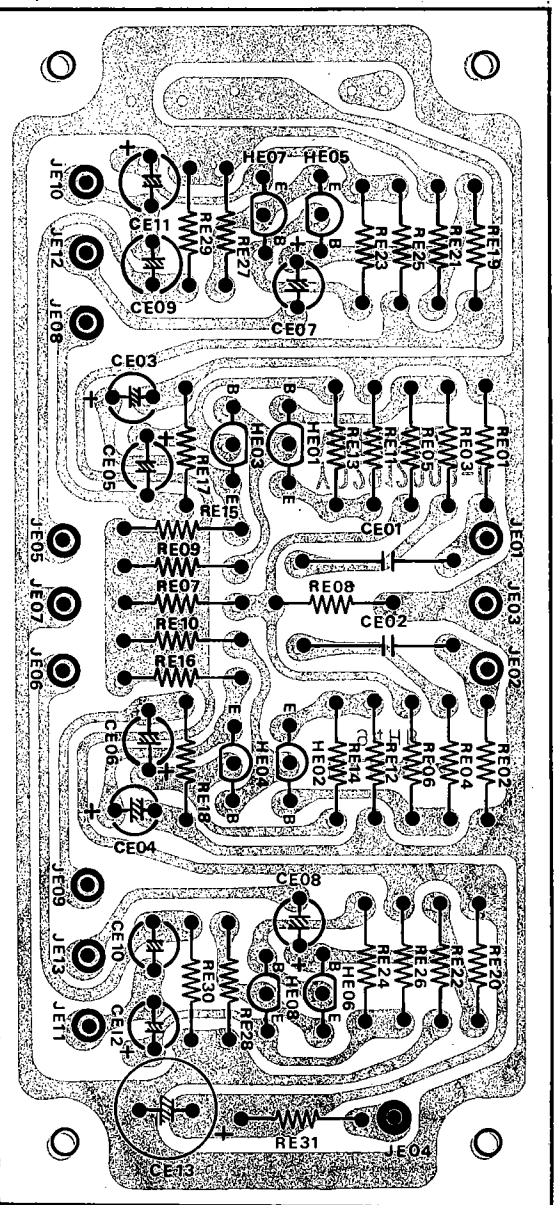

Figure 10. Tone and Pre-Amplifier Assembly PE01 Component Locations

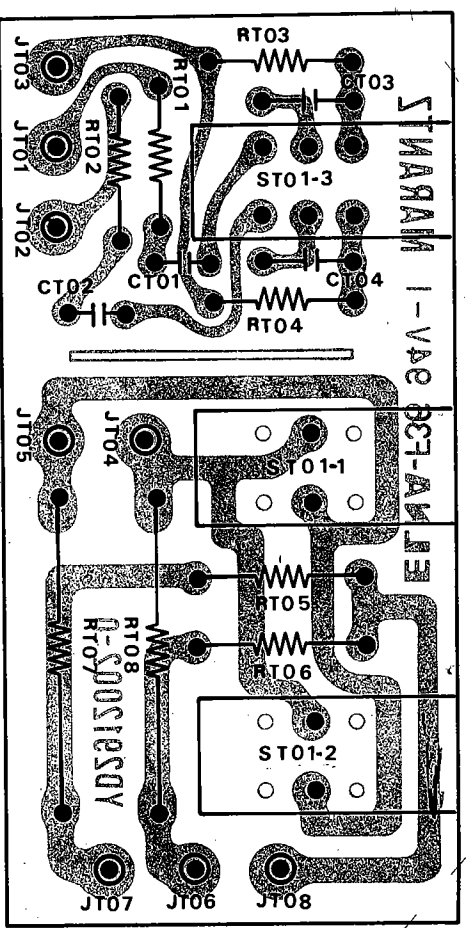

Figure 11. Speaker Loudness Assembly PT01 Component Locations

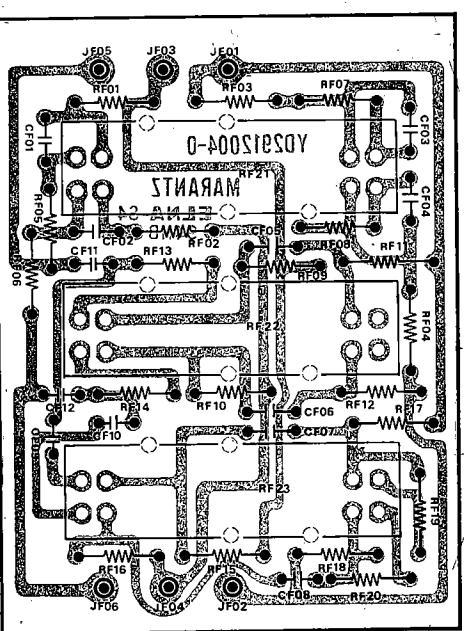

Figure 12. Tone Control Volume Unit PF01 Component Locations

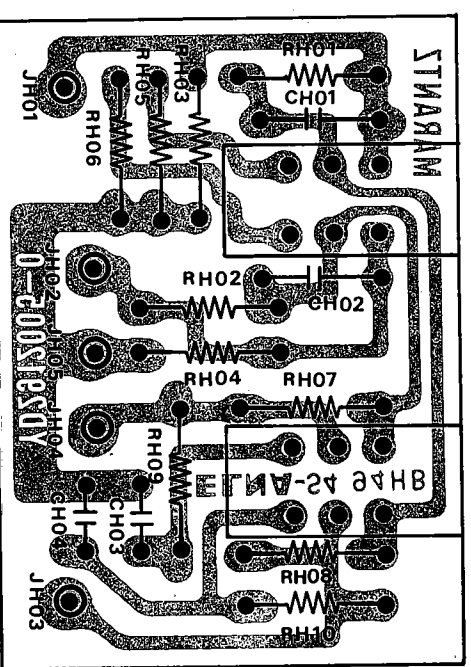

Figure 13. High and Low Filter Unit Assembly PH01 Component Locations

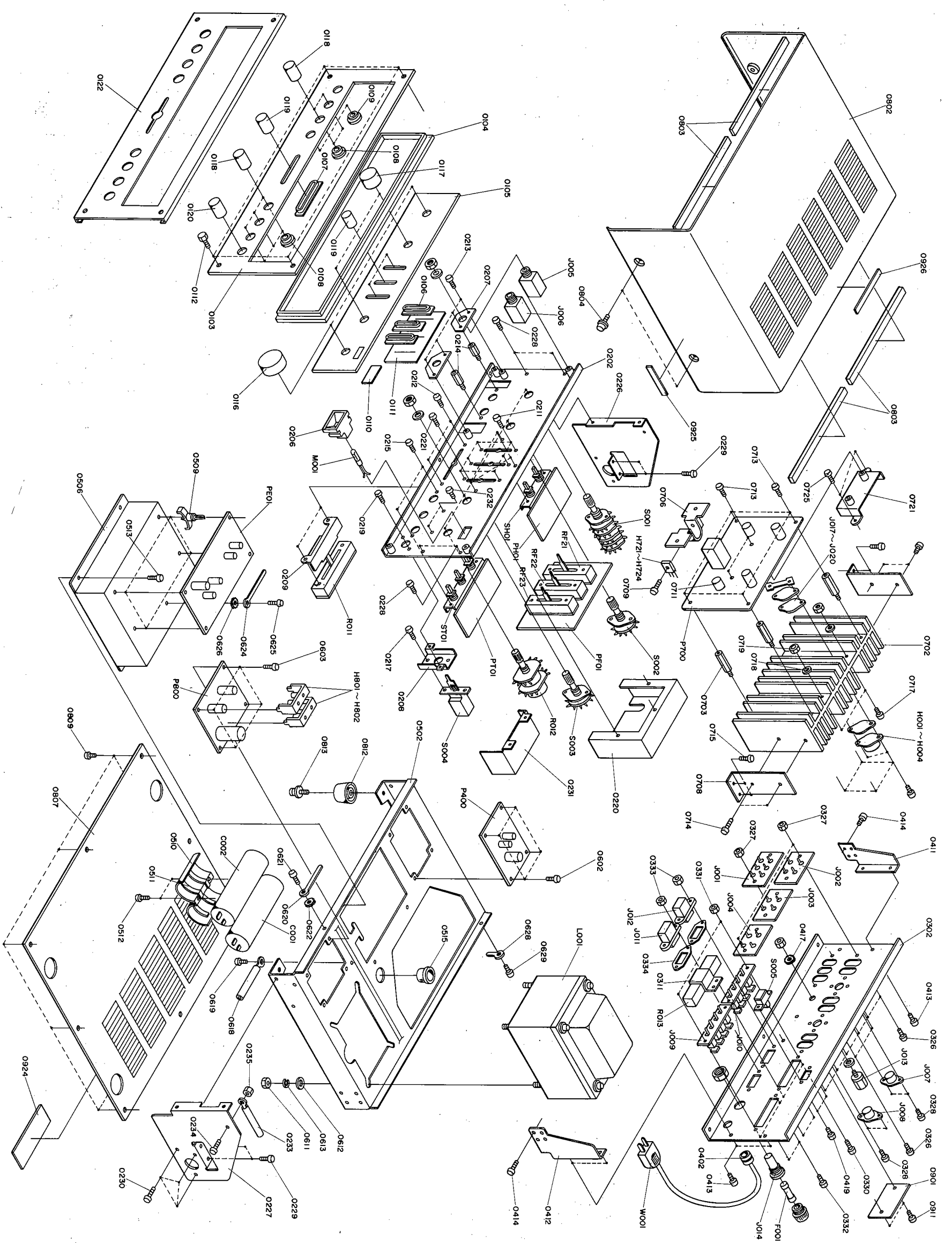

Figure 14. Exploded Mechanical Diagram

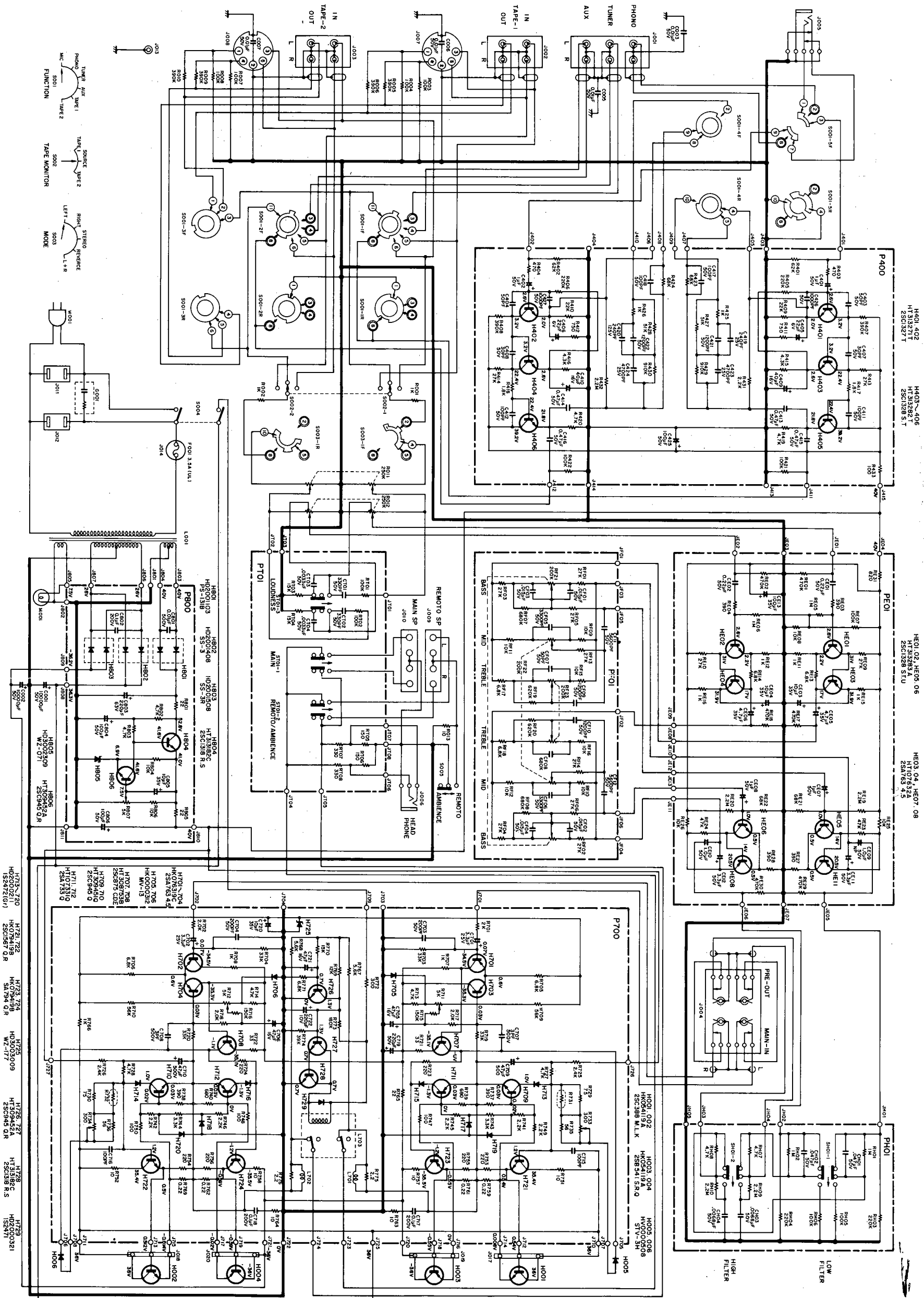

Figure 15. Schematic Diagram

U: For U.S.A.
E: For Europe

REF. DESIG.	U	E	PART NO.	DESCRIPTION
P800	1	1	YD2912006	P800 POWER BOARD
	1	1	ZZ2912006	P W Board Power Supply P W Board Assembly
R801	1	1	GF0522014	Resistor 22Ω ±5% ¼W
R802	1	1	RT0547214	Resistor 4.7KΩ ±5% ¼W
R803	1	1	RT0547214	Resistor 4.7KΩ ±5% ¼W
R804	1	1	RT0510314	Resistor 10KΩ ±5% ¼W
R805	1	1	RC0000012	Resistor 0Ω
R806	1	1	RT0510314	Resistor 10KΩ ±5% ¼W
R807	1	1	RA0502013	Trimming Resist 5KΩ (B) ¼W
C801	1	1	DK1810351	Ceramic Cap 0.01μF 500V
C802	1	1	DF1710452	Film Cap 0.1μF 200V±20%
C803	1	1	EA2270631	Electroly Cap 220μF 63V
C804	1	1	EA1070509	Electroly Cap 100μF 50V ±10%
C805	1	1	EA1060359	Electroly Cap 10μF 35V ±10%
C806	1	1	EA1070509	Electroly Cap 100μF 50V ±10%
H801	1	1	HD2001103	Diode DS-131B
H802	1	1	HD2001408	Diode SS-3
H803	1	1	HD2001508	Diode SS-3R
H804	1	1	HT315092C	Transistor 2SC1509 R.S
H805	1	1	HD3002309	Diode WZ-071
H806	1	1	HT309452A	Transistor 2SC945 QR
J801 ~ J811	11	11	YP1000114	Plug
PE01	1	1	YD2912003	PE01 PRE-TONE BOARD
	1	1	ZZ2912003	P W Board PRE-TONE AMP P W Board Assembly
RE01	1	1	RT0547414	Resistor 470KΩ ±5% ¼W
RE02	1	1	RT0547414	Resistor 470KΩ ±5% ¼W
RE03	1	1	RT0539114	Resistor 390Ω ±5% ¼W
RE04	1	1	RT0539114	Resistor 390Ω ±5% ¼W
RE05	1	1	RT0510514	Resistor 1MΩ ±5% ¼W
RE06	1	1	RT0510514	Resistor 1MΩ ±5% ¼W
RE07	1	1	RT0510414	Resistor 100KΩ ±5% ¼W
RE08	1	1	RT0510314	Resistor 10KΩ ±5% ¼W
RE09	1	1	RT0527314	Resistor 27KΩ ±5% ¼W
RE10	1	1	RT0527314	Resistor 27KΩ ±5% ¼W
RE11	1	1	RT0510214	Resistor 1KΩ ±5% ¼W
RE12	1	1	RT0510214	Resistor 1KΩ ±5% ¼W
RE13	1	1	RT0568214	Resistor 6.8KΩ ±5% ¼W
RE14	1	1	RT0568214	Resistor 6.8KΩ ±5% ¼W
RE15	1	1	RT0510214	Resistor 1KΩ ±5% ¼W
RE16	1	1	RT0510214	Resistor 1KΩ ±5% ¼W
RE17	1	1	RT0547414	Resistor 470KΩ ±5% ¼W
RE18	1	1	RT0547414	Resistor 470KΩ ±5% ¼W
RE19	1	1	RT0522514	Resistor 2.2MΩ ±5% ¼W
RE20	1	1	RT0522514	Resistor 2.2MΩ ±5% ¼W
RE21	1	1	RT0568314	Resistor 68KΩ ±5% ¼W
RE22	1	1	RT0568314	Resistor 68KΩ ±5% ¼W
RE23	1	1	RT0547314	Resistor 47KΩ ±5% ¼W
RE24	1	1	RT0547314	Resistor 47KΩ ±5% ¼W
RE25	1	1	RT0510314	Resistor 10KΩ ±5% ¼W
RE26	1	1	RT0510314	Resistor 10KΩ ±5% ¼W
RE27	1	1	RT0539114	Resistor 390Ω ±5% ¼W
RE28	1	1	RT0539114	Resistor 390Ω ±5% ¼W
RE29	1	1	RT0547414	Resistor 470KΩ ±5% ¼W
RE30	1	1	RT0547414	Resistor 470KΩ ±5% ¼W
RE31	1	1	RT0582114	Resistor 820Ω ±5% ¼W

REF. DESIG.	U	E	PART NO.	DESCRIPTION
CE01	1	1	DF1722405	Film Cap 0.22μF 50V±20%
CE02	1	1	DF1722405	Film Cap 0.22μF 50V±20%
CE03	1	1	EA1060359	Electroly Cap 10μF 35V ±10%
CE04	1	1	EA1060359	Electroly Cap 10μF 35V ±10%
CE05	1	1	EE4750251	Electroly Cap 47μF 35V±20%
CE06	1	1	EE4750251	Electroly Cap 47μF 35V±20%
CE07	1	1	EE1050501	Electroly Cap 1μF 50V±20%
CE08	1	1	EE1050501	Electroly Cap 1μF 50V±20%
CE09	1	1	EQ1050501	Electroly Cap 1μF 50V±30%
CE10	1	1	EQ1050501	Electroly Cap 1μF 50V±30%
CE11	1	1	EE3350501	Electroly Cap 3.3μF 50V±20%
CE12	1	1	EE3350501	Electroly Cap 3.3μF 50V±20%
CE13	1	1	EA1070359	Electroly Cap 100μF 35V ±10%
HE01	1	1	HT313283A	Transistor 2SC1328 S.T.U
HE02	1	1	HT313283A	Transistor 2SC1328 S.T.U
HE03	1	1	HT107632A	Transistor 2SA763
HE04	1	1	HT107632A	Transistor 2SA763
HE05	1	1	HT313283A	Transistor 2SC1328 S.T.U
HE06	1	1	HT313283A	Transistor 2SC1328 S.T.U
HE07	1	1	HT107632A	Transistor 2SA763
HE08	1	1	HT107632A	Transistor 2SA763
JE01 ~ JE13	13	13	YP1000113	Plug
0202	1	1	291216050	Bracket K, Front Chassis K
0206	1	1	291225901	Bush, Pilot Light
0209	1	1	291210903	Shield, Slider Mounting
0211	6	6	51102605A	B H M Screw B 2.6 x 5
0212	2	2	51100306A	B H M Screw B 3 x 6
0213	4	4	51040305A	F H M Screw F 3 x 5
0214	2	2	291210102	Support, Stand-Off
0215	2	2	51100306A	B H M Screw B 3 x 6
0220	1	1	291210904	Shield, For PF01
0221	3	3	51100306A	B H M Screw B 3 x 6
0226	1	1	282816013	Bracket, Chassis, Left
0227	1	1	282816014	Bracket, Chassis, Right
0228	4	4	51100306A	B H M Screw B 3 x 6
0231	1	1	29121090	Shield
0232	2	2	51100306A	B H M Screw B 3 x 6
0234	1	1	51100306A	B H M Screw B 3 x 6
0235	1	1	53110303A	Hexagon Nut
0219	2	2	51100306A	B H M Screw B 3 x 6
PT01	1	1	YD2912002	PT01 SP-LOUDNESS BOARD
	1	1	ZZ2912002	P W Board SP-LOUDNESS P W Board Assembly
RT01	1	1	RT0510414	Resistor 100KΩ ±5% ¼W
RT02	1	1	RT0510414	Resistor 100KΩ ±5% ¼W
RT03	1	1	RT0515314	Resistor 15KΩ ±5% ¼W
RT04	1	1	RT0515314	Resistor 15KΩ ±5% ¼W
RT05	1	1	GJ0515101	Resistor 150Ω ±5% 1W
RT06	1	1	GJ0515101	Resistor 150Ω ±5% 1W
RT07	1	1	GJ0533102	Resistor 330Ω ±5% 2W
RT08	1	1	GJ0533102	Resistor 330Ω ±5% 2W
CT01	1	1	DD1533101	Ceramic Cap 330PF 50V±10%
CT02	1	1	DD1533101	Ceramic Cap 330PF 50V±10%
CT03	1	1	DF1633305	Film Cap 0.033μF 50V±10%
CT04	1	1	DF1633305	Film Cap 0.033μF 50V±10%
ST01	1	1	SP0203003	Push SW

REF. DESIG.	U	E	PART NO.	DESCRIPTION
JT01 ~ JT08	8	8	YP1000113	Plug
PF01 TONE, VOLUME BOARD				
PF01	1	1	YD2912004	P W Board TONE VOLUME
	1	1	ZZ2912004	P W Board Assembly
RF01	1	1	RT0527314	Resistor 27KΩ ±5% ¼W
RF02	1	1	RT0527314	Resistor 27KΩ ±5% ¼W
RF03	1	1	RT0527314	Resistor 27KΩ ±5% ¼W
RF04	1	1	RT0527314	Resistor 27KΩ ±5% ¼W
RF05	1	1	RT0527314	Resistor 27KΩ ±5% ¼W
RF06	1	1	RT0527314	Resistor 27KΩ ±5% ¼W
RF07	1	1	RT0568414	Resistor 680KΩ ±5% ¼W
RF08	1	1	RT0568414	Resistor 680KΩ ±5% ¼W
RF09	1	1	RT0510314	Resistor 10KΩ ±5% ¼W
RF10	1	1	RT0510314	Resistor 10KΩ ±5% ¼W
RF11	1	1	RT0510314	Resistor 10KΩ ±5% ¼W
RF12	1	1	RT0510314	Resistor 10KΩ ±5% ¼W
RF13	1	1	RT0527314	Resistor 27KΩ ±5% ¼W
RF14	1	1	RT0527314	Resistor 27KΩ ±5% ¼W
RF15	1	1	RT0510314	Resistor 10KΩ ±5% ¼W
RF16	1	1	RT0510314	Resistor 10KΩ ±5% ¼W
RF17	1	1	RT0568214	Resistor 6.8KΩ ±5% ¼W
RF18	1	1	RT0568214	Resistor 6.8KΩ ±5% ¼W
RF19	1	1	RT0562414	Resistor 620KΩ ±5% ¼W
RF20	1	1	RT0562414	Resistor 620KΩ ±5% ¼W
RF21	1	1	RS0204001	Variable Resist 200KΩ (B) BASS
RF22	1	1	RS0204001	Variable Resist 200KΩ (B) MID
RF23	1	1	RS0204001	Variable Resist 200KΩ (B) TREBLE
CF01	1	1	DF1615305	Film Cap 0.015µF 50V±10%
CF02	1	1	DF1615305	Film Cap 0.015µF 50V±10%
CF03	1	1	DF1615305	Film Cap 0.015µF 50V±10%
CF04	1	1	DF1615305	Film Cap 0.015µF 50V±10%
CF05	1	1	DF1633205	Film Cap 3300PF 50V±10%
CF06	1	1	DF1633205	Film Cap 3300PF 50V±10%
CF07	1	1	DD1650001	Ceramic Cap 50PF 50V±10%
CF08	1	1	DD1650001	Ceramic Cap 50PF 50V±10%
CF09	1	1	DF1612205	Film Cap 1200PF 50V±10%
CF10	1	1	DF1612205	Film Cap 1200PF 50V±10%
CF11	1	1	DF1656205	Film Cap 5600PF 50V ±10%
CF12	1	1	DF1656205	Film Cap 5600PF 50V±10%
JF01 ~ JF06	6	6	YP1000113	Plug
R011	1	1	RS0254006	Variable Res 250KΩ Balance
S004	1	1	SP0201015	Push SWITCH POWER SWITCH
G001	1		BF1040002	Ceramic Cap
C004		1	DF1722380	Film Cap 0.02µF 1000V
0208	1	1	291216011	Bracket POWER SWITCH
0217	2	2	51100306A	B H M Screw B 3 x 6
J005	1	1	YJ0100087	Jack MIC
0207	1	1	291212001	Insulator MIC
J006	1	1	YJ0100065	Jack HEAD PHONE
3636	1	1	291212001	Insulator HEAD PHONE
PH02 HI, LOW FILTER BOARD				
PH01	1	1	YD2912005	P W Board HI, LOW, FILTER
	1	1	ZZ2912005	P W Board Assembly

REF. DESIG.	U	E	PART NO.	DESCRIPTION
RH01	1	1	RT0510514	Resistor 1MΩ ±5% ¼W
RH02	1	1	RT0510514	Resistor 1MΩ ±5% ¼W
RH03	1	1	RT0522414	Resistor 220KΩ ±5% ¼W
RH04	1	1	RT0522414	Resistor 220KΩ ±5% ¼W
RH05	1	1	RT0510414	Resistor 100KΩ ±5% ¼W
RH06	1	1	RT0510414	Resistor 100KΩ ±5% ¼W
RH07	1	1	RT0547214	Resistor 4.7KΩ ±5% ¼W
RH08	1	1	RT0547214	Resistor 4.7KΩ ±5% ¼W
RH09	1	1	RT0522514	Resistor 2.2MΩ ±5% ¼W
RH10	1	1	RT0522514	Resistor 2.2MΩ ±5% ¼W
CH01	1	1	DF1647305	Film Cap 0.047µF 50V±10%
CH02	1	1	DF1647305	Film Cap 0.047µF 50V±10%
CH03	1	1	DF1668205	Film Cap 0.0068µF 50V±10%
CH04	1	1	DF1668205	Film Cap 0.0068µF 50V±10%
SH01	1	1	SP0202012	Push SWITCH
JH01 ~ JH05	5	5	YP1000114	Plug
S001	1	1	SR0406004	Rotary SW SELECTOR
S002	1	1	SR0203004	Rotary SW TAPE MONITOR
R001	1	1	RT0510214	Resistor 1KΩ ±5% ¼W
R002	1	1	RT0510214	Resistor 1KΩ ±5% ¼W
S003	1	1	SR0205008	Rotary SW MODE
R012	1	1	RM0254028	Variable Res. MASTER VR250K
M001	1	1	IN1008030	Lamp, Pilot Indicator
0233	1	1	121000501	Clamper
0302	1		291216002	Bracket, Rear Panel
0304	1	1	291216004	Bracket, Rear Panel
0311	1	1	291200502	Clamper
0326	8	8	51100308S	B H M Screw B 3 x 4
0327	8	8	53110303A	Hexagon Nut
0328	4	4	51570306B	P H Tapt Screw P 3 x 6 ST
0330	4	4	51100-308S	B H M Screw B 3 x 8
0331	2	2	53110303A	Hexagon Nut
0332	4	4	51100308S	B H M Screw B 3 x 8
0333	4	4	53110303S	Hexagon Nut
0334	2	2	289611801	Spacer, A.C. Outlet
0402	1		145525903	Bush
0403	1		282125901	Bush
0404	2		53110303A	Hexagon Nut
0405	2		54050300R	T L Washer OR
0406	2		51060316A	P H M Screw P 3 x 16
0407	2		55060305S	T R Rivet
0408	1		284906702	Cap
0411	1	1	282816003	Bracket, Rear Corner, Left
0412	1	1	282816004	Bracket, Rear Corner, Right
0413	4	4	51100306S	B H M Screw B 3 x 6
0417	1	1	54050400R	T L Washer OR
0419	2	2	51100306S	B H M Screw B 3 x 6
R003	1	1	RT0510414	Resistor 100Ω ±5% ¼W
R004	1	1	RT0510414	Resistor 100Ω ±5% ¼W
R005	1	1	RT0539414	Resistor 390KΩ ±5% ¼W
R006	1	1	RT0539414	Resistor 390KΩ ±5% ¼W
R007	1	1	RT0510414	Resistor 100Ω ±5% ¼W
R008	1	1	RT0510414	Resistor 100Ω ±5% ¼W
R009	1	1	RT0539414	Resistor 390KΩ ±5% ¼W
R010	1	1	RT0539414	Resistor 390KΩ ±5% ¼W
R013	1	-1	GS1010020	Resistor 10Ω ±10% 20W

U: For U.S.A.
E: For Europe

REF. DESIG.	U	E	PART NO.	DESCRIPTION
C006	1	1	DK1710301	Ceramic Cap 0.01 μ F 50V
C007	1	1	DK1710301	Ceramic Cap 0.01 μ F 50V
W001	1	1	YC0240010	AC Cord
F001	1	1	FS1035001	Fuse 3.5A UL
F002	1	1	FS2035091	Fuse 3.5A UL
J001	1	1	YT0206006	Terminal PHONO TUNER AUX
J002	1	1	YT0204008	Terminal TAPE-1
J003	1	1	YT0204008	Terminal TAPE-2
J004	1	1	YT0204009	Terminal MAIN-IN, PRE-OUT
J007	1	1	YJ1100016	Socket TAPE-1 DIN
J008	1	1	YJ1100016	Socket TAPE-2 DIN
J009	1	1	YT0304006	Terminal SPEAKER
J010	1	1	YT0304006	Terminal SPEAKER
J011	1	1	YJ0400048	Socket AC OUTLET
J012	1	1	YJ0400048	Socket AC OUTLET
J013	1	1	YT0101003	Terminal GROUND
J014	1	1	YJ0800012	Socket FUSE HOLDER
S005	1	1	SS0202038	Slide SWITCH AMBIENCE
0628	1	1	62030039W	Lug
C003	1	1	DK1710301	Ceramic Cap 0.01 μ F 50V
C005	1	1	DK1710301	Ceramic Cap 0.01 μ F 50V
0316	1	1	281816006	Bracket
0317	4	1	51100312A	B H M Screw B 3 x 12
0322	1	1	285412001	Insulator
J025	1	1	YL0106004	Terminal
0618	2	2	138200503	Clamper
F001	1	1	FS1030090	Fuse 3A
F002	1	1	FS1010090	Fuse 1A
F003	1	1	FS1010090	Fuse 1A
F004	1	1	FS1005090	Fuse 0.5A
J021	1	1	YJ0800009	Socket
J022	1	1	YJ0800009	Socket
J023	1	1	YJ0800009	Socket
J024	1	1	YJ0800009	Socket
0521	1	1	282816012	Bracket
0522	4	1	51100306A	B H M Screw B 3 x 6
0523	4	1	53110303A	Hexagon Nut
0524	1	1	282826514	Indicator
0319	1	1	282126902	Protector
0320	1	1	288912005	Insulator
0506	1	1	291205350	Cover K, Filters
0509	4	4	291210105	Support, For PE01
0512	2	2	51100306A	B H M Screw B 3 x 9
0624	1	1	138200503	Clamper
0625	1	1	51570305B	P H Tapt Screw P 3 x 5 ST
0626	1	1	54050300R	T L Washer OR
C001	1	1	EC1090501	Electroly Cap 10,000 μ F 50V
C002	1	1	EC1090501	Electroly Cap 10,000 μ F 50V
0510	1	1	291200501	Clamper, Filter Holder
0511	2	2	291211801	Spacer, Filter Holder
0229	4	4	51570306B	P H Tapt Screw P 3 x 6 ST
0230	6	6	51100304A	B H M Screw B 3 x 4
0318	2	2	51100306S	B H M Screw B 3 x 6
0321	2	2	51100306S	B H M Screw B 3 x 6
0323	4	4	51100306S	B H M Screw B 3 x 6

REF. DESIG.	U	E	PART NO.	DESCRIPTION
0324	4	4	53110303A	Hexagon Nut
0414	8	8	51100304A	B H M Screw B 3 x 4
0502	1	1	291210501	Chassis, Main
0513	4	4	51570306B	P H Tapt Screw P 3 x 6 ST
0515	1	1	273025901	Bush, Insulation
0602	4	4	51570306B	P H Tapt Screw P 3 x 6 ST
0603	4	4	51570306B	P H Tapt Screw P 3 x 6 ST
0611	4	4	53110401A	Hexagon Nut
0612	4	4	54020401A	Flat Washer P
0613	4	4	54040402A	Spring Washer
0619	2	2	51570306B	P H Tapt Screw P 3 x 6 ST
0620	1	1	138200503	Clamper
0621	1	1	51570306B	P H Tapt Screw P 3 x 6 ST
0622	1	1	54050300R	T L Washer OR
0629	1	1	51570306B	P H Tapt Screw P 3 x 6 ST
0715	4	4	51570306B	P H Tapt Screw P 3 x 6 ST
0812	4	4	275905701	Leg
0813	4	4	51490410S	B H M Screw F S B 4 x 10 F/S
0931	1	1	28868610	Label Marantz
L001	1	1	TS1960208	Transformer, Power
L001	1	1	TS1960209	Transformer, Power
0112	4	4	52017039J	Bolt, Front Panel
0116	2	2	282815401	Knob SELECTOR BALANCE
0117	2	2	282815402	Knob MODE TAPE MONITOR
0118	5	5	281815401	Knob HI LOW FILTER
0119	4	4	285015401	Knob LOUDNESS SPEAKER BALANCE
0120	1	1	290415404	Knob BASS TREBLE MID
0802	1	1	282825701	Lid, Top Cover
0803	4	4	257711807	Spacer, For Lid
0804	4	4	51480406S	B H M Screw F B 4 x 6 F
0807	1	1	282825702	Lid, Bottom Cover
0809	8	8	51100406S	B H M Screw B 4 x 6
0901	1	1	291226501	Indicator Name Plate
0903	1	1	291226503	Indicator Name Plate
0911	2	2	51100305S	B H M Screw B 3 x 5
0913	1	1	282186102	Label Caution
0914	1	1	951091102	Label UL FACTORY CODE
0915	1	1	951120101	Label UL
0924	1	1	257886101	Label CAUTION: TO PREVENT
0925	1	1	257886102	Label DO NOT REMOVE
0926	1	1	257886103	Label SEE MARKING
1122	4	4	952281501	Serial No Card
1124	4	4	952301512	Serial No Card
1002	1	1	291285101	Owner Instruction Manual
1004	1	1	291285122	Instructions Set
1005	1	1	288685110	Instructions Set
1011	1	1	291285601	Schematic
1012	1	1	291285602	Schematic
1020	1	1	281885104	Instructions Packing
1021	1	1	282885108	Instructions Accessories
1022	1	1	288585107	Instructions Misc.
1024	1	1	281881301	Envelope
1026	1	1	257785401	Guarantee Card
1027	1	1	257785102	Instructions Red Tag
1028	1	1	257781301	Envelope
1102	1	1	291280101	Packing Case Inner Carton
1103	1	1	291280111	Packing Case Outer Carton
1108	2	2	289180301	Partitioner (Cushion)
1112	1	1	901383033	Polyethylene Bag, Set

U: For U.S.A.
E: For Europe

REF. DESIG.	U	E	PART NO.	DESCRIPTION
1114	1	1	901302501	Polyethylene Bag, Printed Material
1117	1	1	102980401	Sleeve, AC Cord
1118		1	956000004	Hang Tag Voltage Indicator
1119	2	2	273182101	Silicagel (Disecant)
			291285501	Service Manual

REF. DESIG.	U	E	PART NO.	DESCRIPTION
-------------	---	---	----------	-------------

10. TECHNICAL SPECIFICATIONS

Gain-Phono (low level) to pre-amp	55dB
Output	
Phono to recording output	40dB
High level to pre-amp output	15dB
Input Impedance-Low level input	Phono 47K
	Microphone 47K
High level input	> 50K
Input sensitivity-Phono (low)	1.8mV to equal 1 volt output at pre-amp out
Frequency Response	±1.0dB, 20Hz to 20KHz at rated power output
Intermodulation Distortion	Less than 0.3% at rated power output (S.M.P.T.E.)
Damping Factor (20 to 20KHz)	Greater than 20 into 8 ohms load
Total Noise-From magnetic	Less than 1.5 μ V equivalent input at rated phono input to power amp output output into 8 ohms
Volume Tracking	Within 3dB
*Power Output, Band, THD	
Rated Power Output	
(continuous average per channel, all channels driven).	
Power output	38 watts 4 ohms
Power band	20Hz to 20KHz
Total Harmonic Distortion (THD)	0.3%
Power Requirement	120V AC, 50 to 60Hz
At rated output both channels operating	190 Watts
Idling Power (volume control at zero)	48 Watts
Dimensions-Panel width	14-11/64 inches
Panel Heigth.	4-23/32 inches
Depth	11-1/32 inches
Weight-Unit alone	18 lbs.
Packed for shipment	25.3 lbs.

* Power Output Specified in accordance with Federal Trade Commission (FTC) regulations.

NOTE: These specifications and exterior designs may be changed for improvement without advance notice.

SERVICE INFORMATION FOR EUROPEAN MODEL

The information contained here in included the rear panel and main chassis component locations, schematic diagram and voltage conversion.

For the circuit description, alignment method and repairing hints, refer to the original service manual.

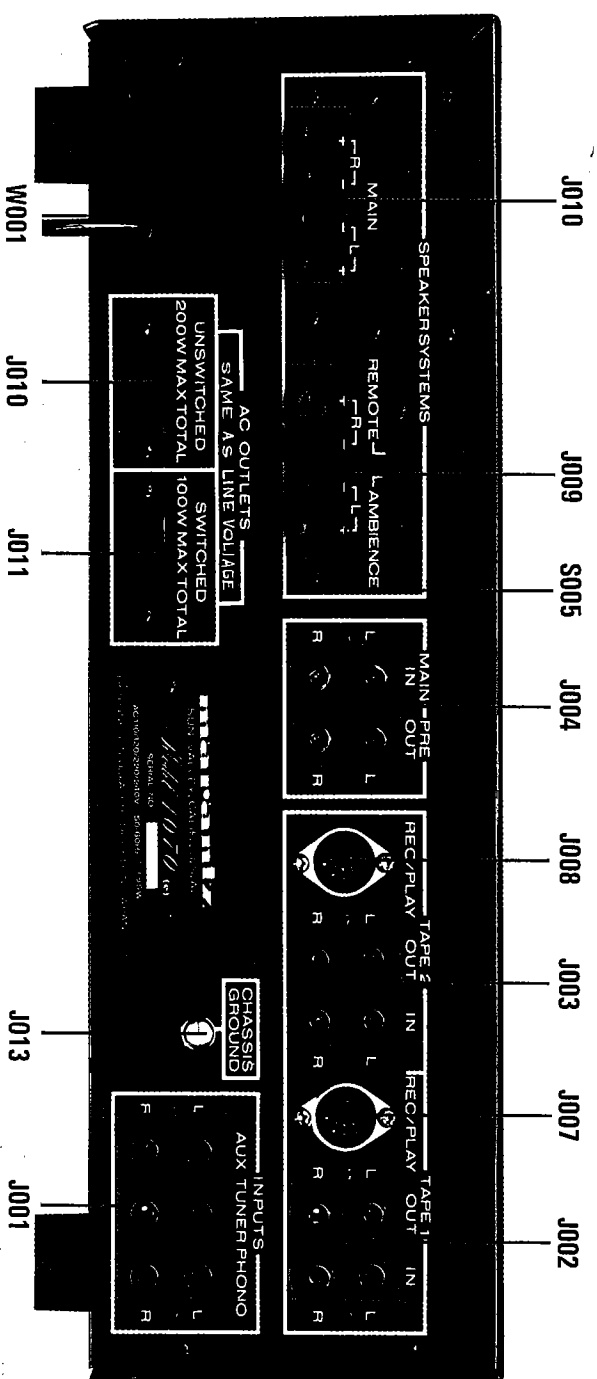

Figure 16. Rear Panel Adjustment and Component Locations

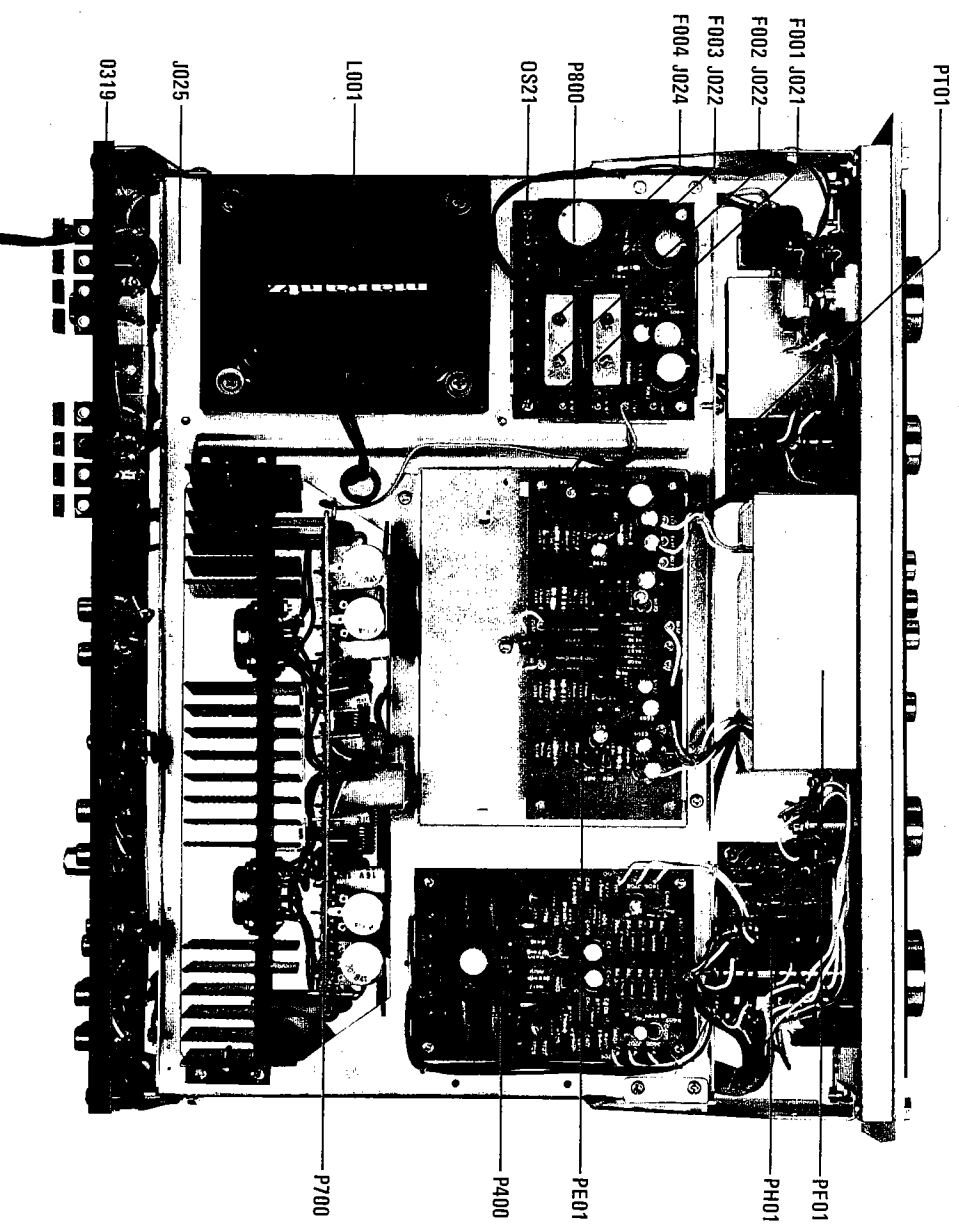

Figure 17. Main Chassis Component Locations (Bottom View)

VOLTAGE CONVERSION

This model is equipped with a universal power transformer to permit operation at 110, 120, 220 and 240V AC 50 to 60Hz.

To convert the unit to the required voltage perform the following steps:

- (1) Remove the cover.
- (2) Change the jumper wires at illustrated below for the required AC voltage.

CAUTION: DISCONNECT POWER SUPPLY CORD FROM AC OUTLET BEFORE CONVERTING VOLTAGE.

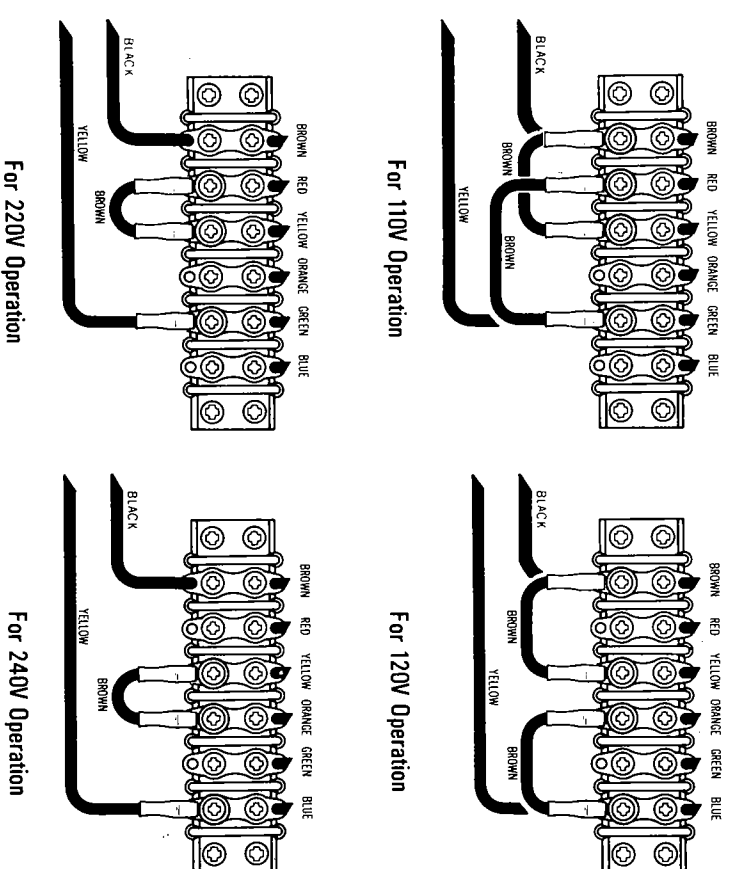

Figure 18. Voltage Conversion Chart

Instruction for the use in the range other than specified in FTZ codes

Achtung für die Leute, die in dem Gebiet wohnen, wo die FTZ-Bestimmungen vorherrschend sind.

Sollte das Gerät auch für Frequenzen ausserhalb des in den FTZ-Bestimmungen angegebenen Bereiches empfangsbereit sein, bitten wir, den Bereich durch Nachstellen des Kernes in der Oszillatordspule (in der Abbildung mit "FTZ" gekennzeichnet) so zu korrigieren, dass er den Bestimmungen entspricht.

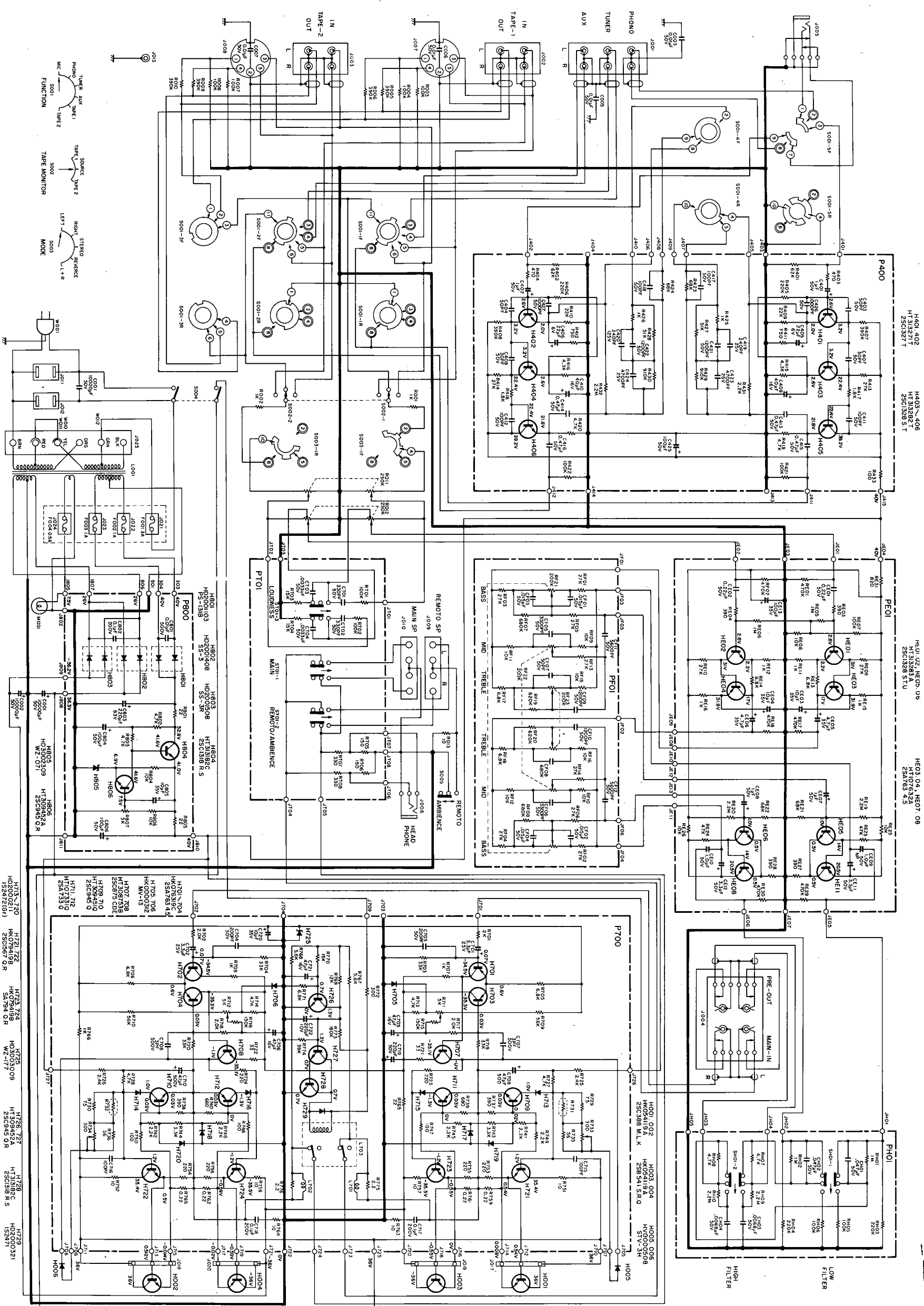
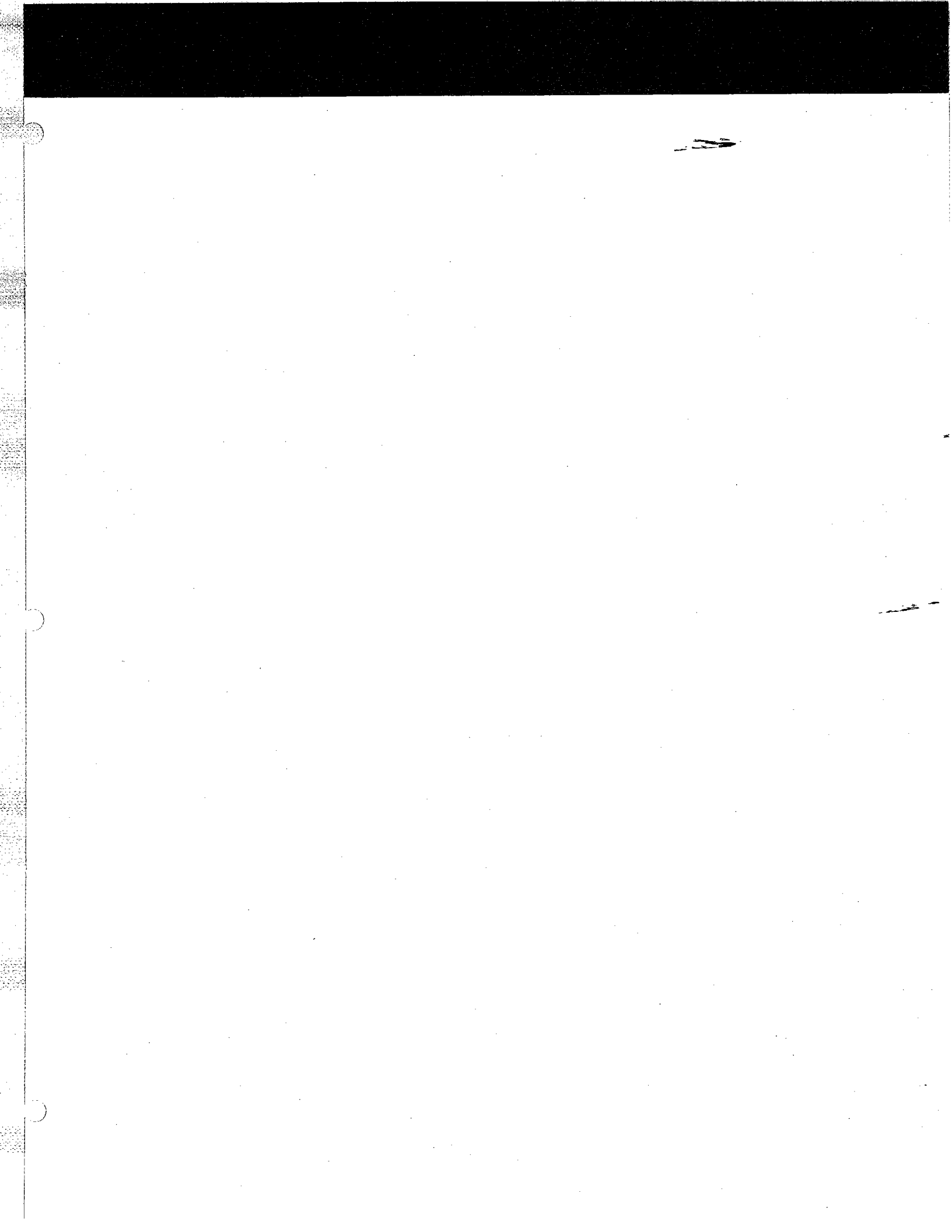

Figure 20. Schematic Diagram.





marantz

MARANTZ CO., INC. · P. O. BOX 99 · SUN VALLEY, CALIFORNIA · 91352

•
A WHOLLY-OWNED SUBSIDIARY OF SUPERSCOPE INC., SUN VALLEY, CALIFORNIA 91352